

# Sulion

## Emma

Ref.: 2242057 / 2242064



Video de instalación / Installation video / Vidéo d'installation / Video de instalação / Installationsvideo / Video dell'installazione / Βίντεο εγκατάστασης





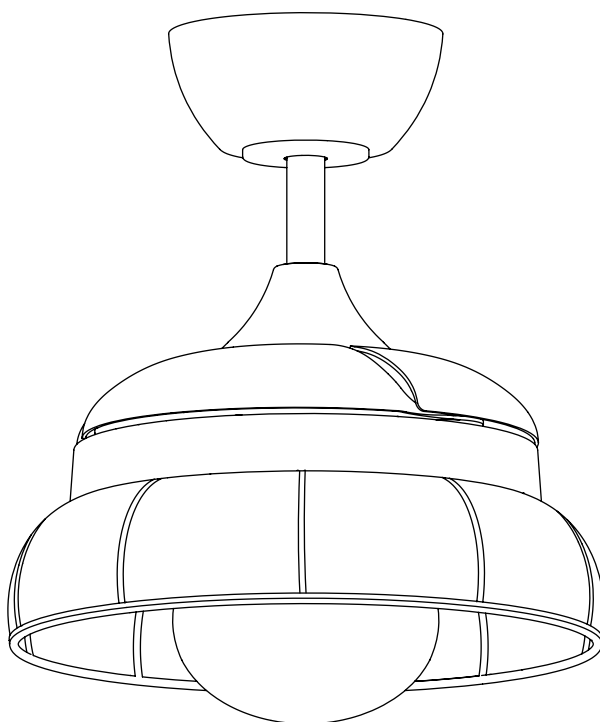













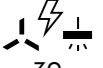













 **SAT**

[sulion.es](http://sulion.es)   
**+34 621262721**    
[sat@sulion.es](mailto:sat@sulion.es) 





















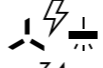













# Emma 55

Ref.: 2242057



 220-240V ~AC A1	 50/60 Hz A2	 IP 20 A3	 IP 20 A6	 -5↔40°C A9	 15° A10	 4,5 kg A11	 <0,5W A12
 39 kWh/1000h A13	 2100 lm B1	 12W B2	 C B3	 CCT 2700 K 4000 K B6	 360° B7	 120° B8	 CRI 80 B9
 30.000 h B10	 10.000 B11	 B12	 B15	 B18	 2,98 m³/min/W D7	 2,4 m/s D8	 IEC 60879: 2019 D9
 E2	 433.92 MHz E4	 10 dBm E5					
 n° D1	 W D2	 RPM D3	 m³/min D4	 m³/h D5	 dB D6		
10	27	200	14	830	34		

# Emma 89

Ref.: 2242064

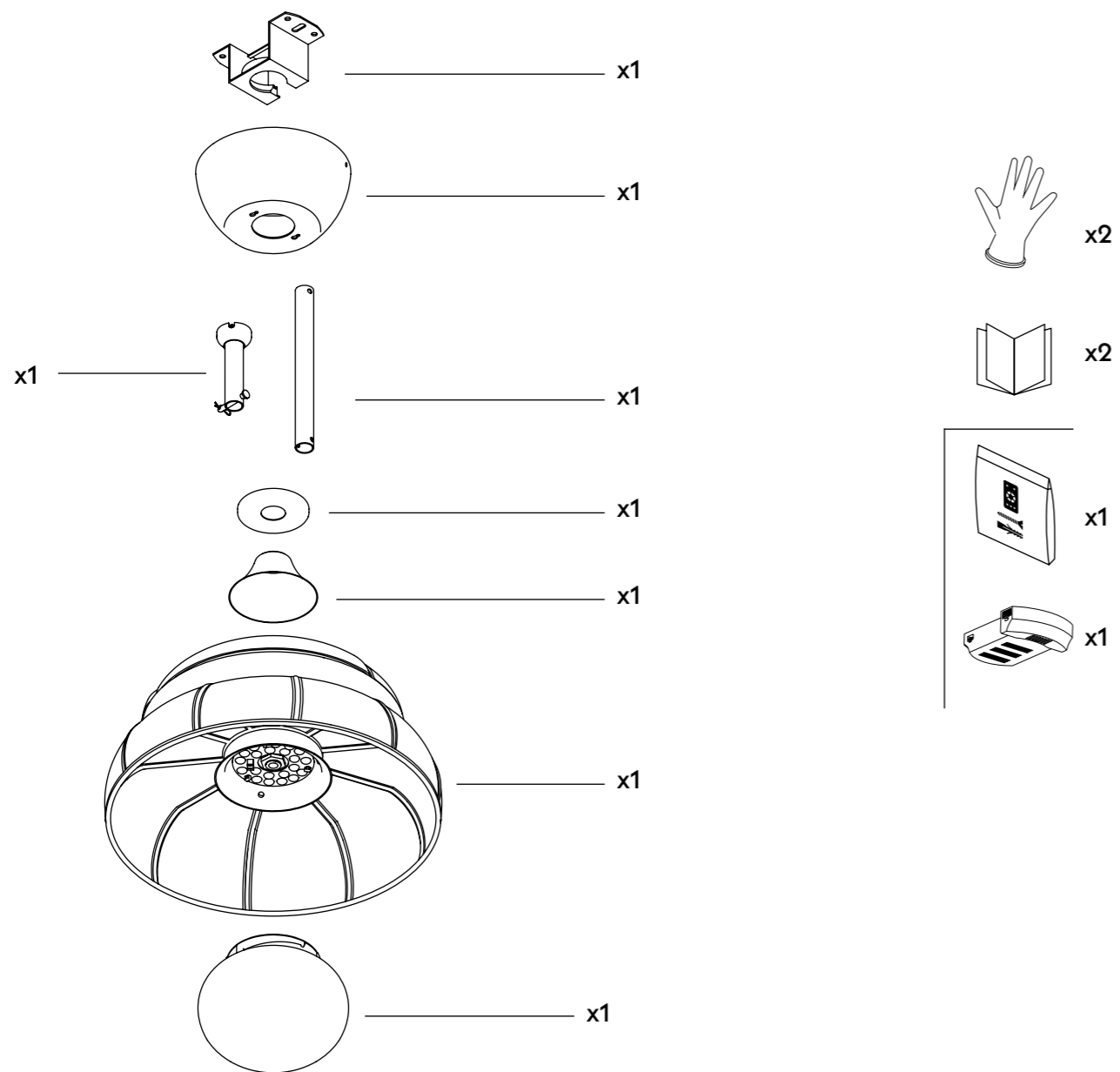
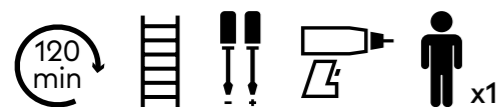
 220-240V ~AC A1	 50/60 Hz A2	 IP 20 A3	 IP 20 A6	 -5↔40°C A9	 15° A10	 6,7 kg A11	 <0,5W A12
 34 kWh/1000h A13	 3000 lm B1	 16W B2	 C B3	 CCT 2700 K 4000 K B6	 360° B7	 120° B8	 CRI 80 B9
 30.000 h B10	 10.000 B11	 B12	 B15	 B18	 5,3 m³/min/W D7	 2,2 m/s D8	 IEC 60879: 2019 D9
 E2	 433.92 MHz E4	 10 dBm E5					
 n° D1	 W D2	 RPM D3	 m³/min D4	 m³/h D5	 dB D6		
10	18	346	96	5760	46		



ES Solución de incidencias / FAQ. Preguntas frecuentes / Control de dos o más ventiladores con un único control remoto  
 EN Troubleshooting / FAQ. Frequently asked questions / Control two or more fans with a single remote control  
 FR Dépannage / FAQ. Questions fréquemment posées / Contrôle de deux ou plusieurs ventilateurs avec une seule télécommande  
 PT Solução de problemas / FAQ. Perguntas frequentes / Controlo de dois ou mais ventiladores com um único comando à distância  
 DE Fehlerbehebung / FAQ. Häufig gestellte Fragen / Steuerung von zwei oder mehr Ventilatoren mit einer einzigen Fernbedienung  
 IT Risoluzione dei problemi / FAQ. Domande frequenti / Controllo di due o più ventilatori con un unico telecomando  
 EL Επίλυση προβλημάτων / FAQ. Συχνές ερωτήσεις / Ρύθμιση δύο ή περισσότερων ανεμιστήρων με ένα τηλεχειριστήριο

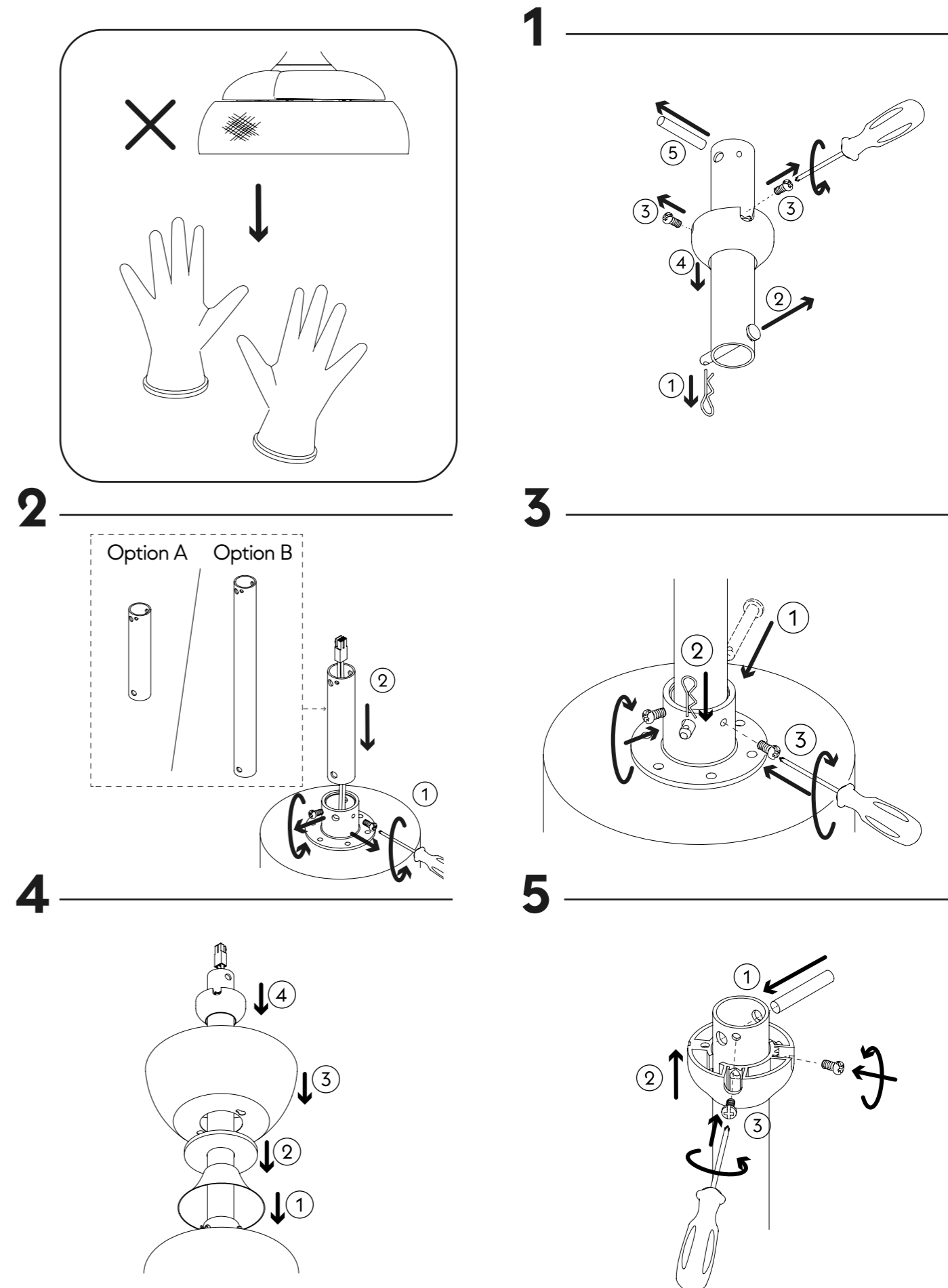

6

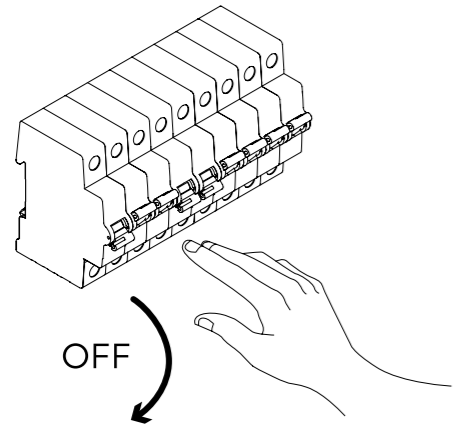

7

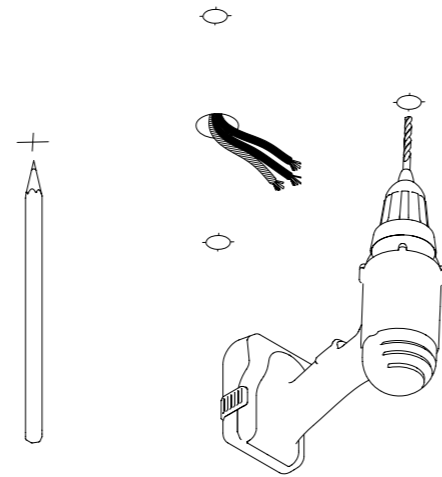

11

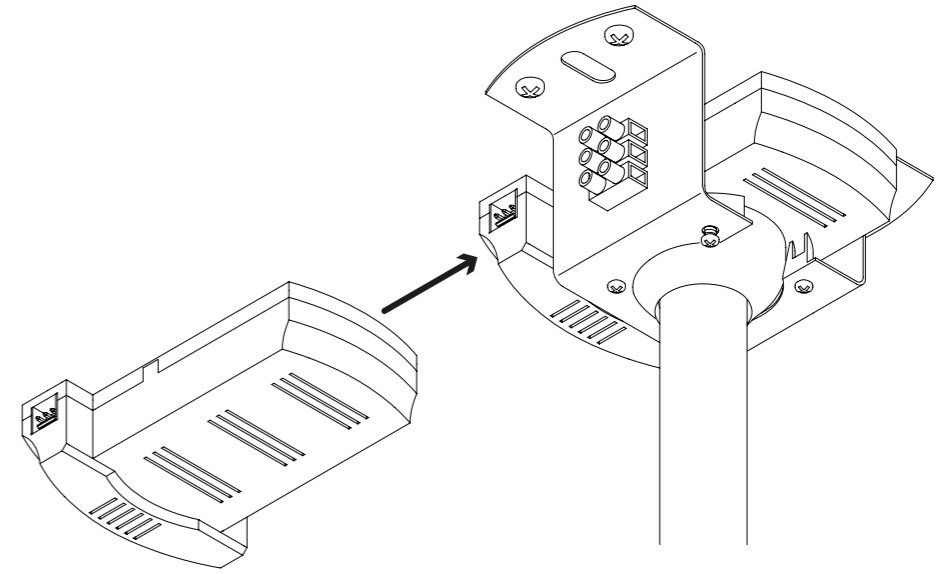

8

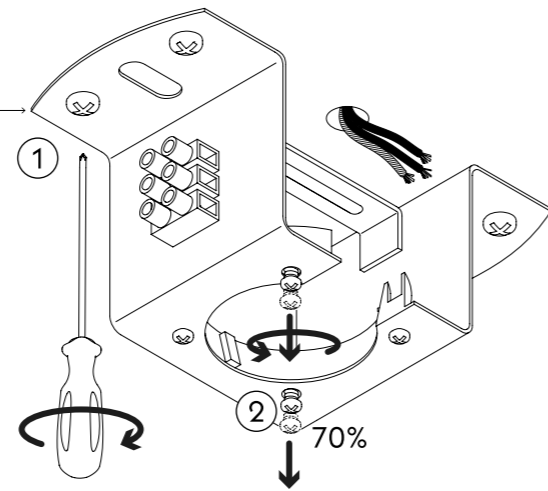
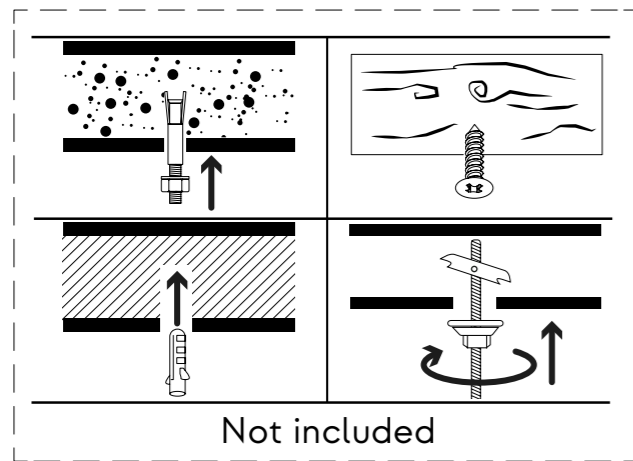

12

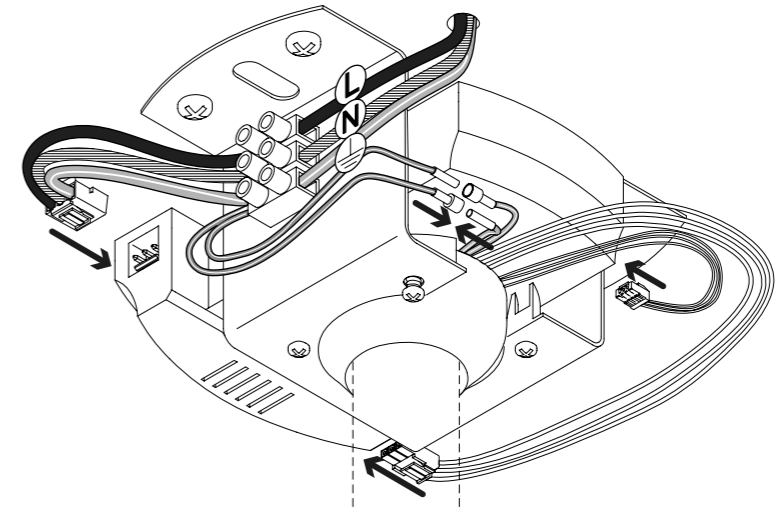

9

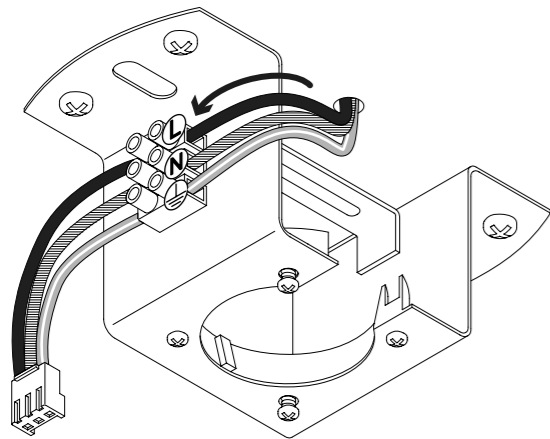

10

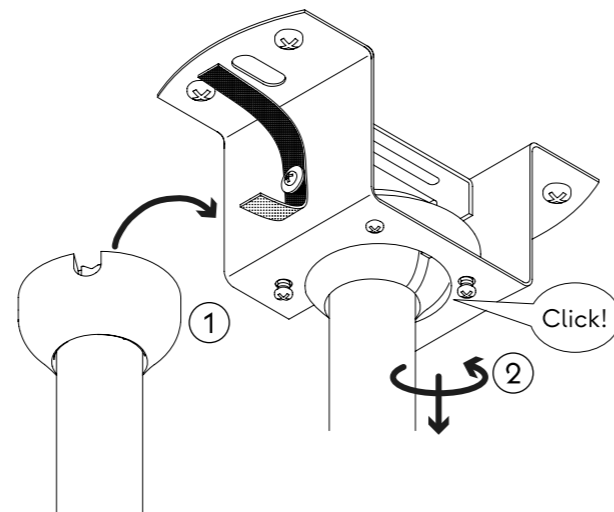

13

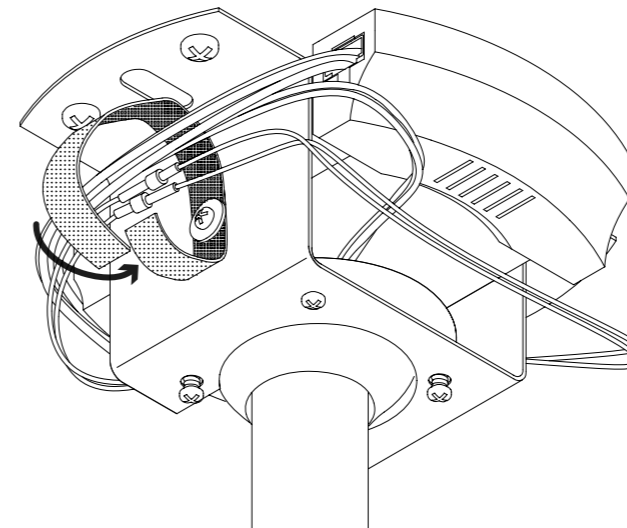

14

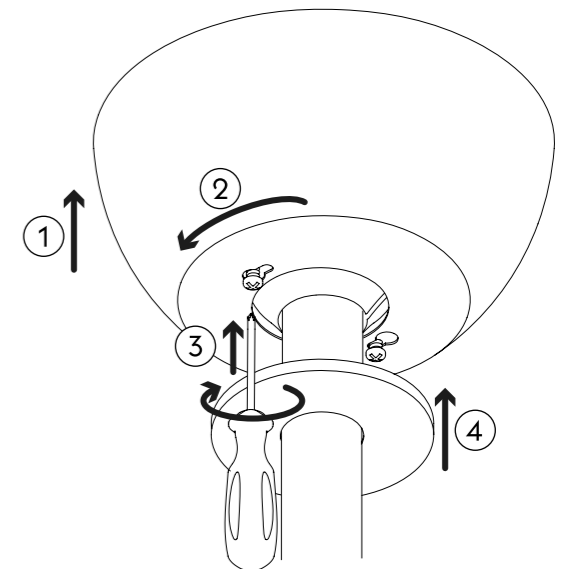

15

---

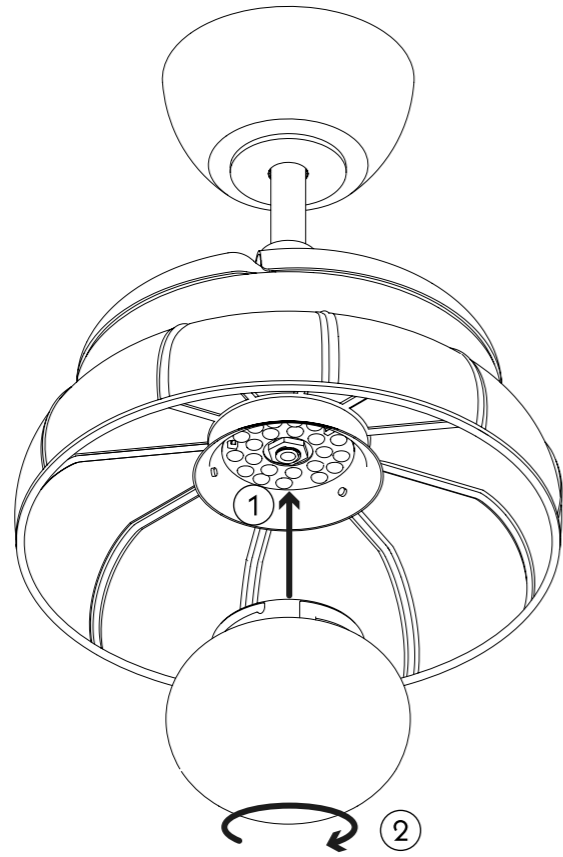

16

---

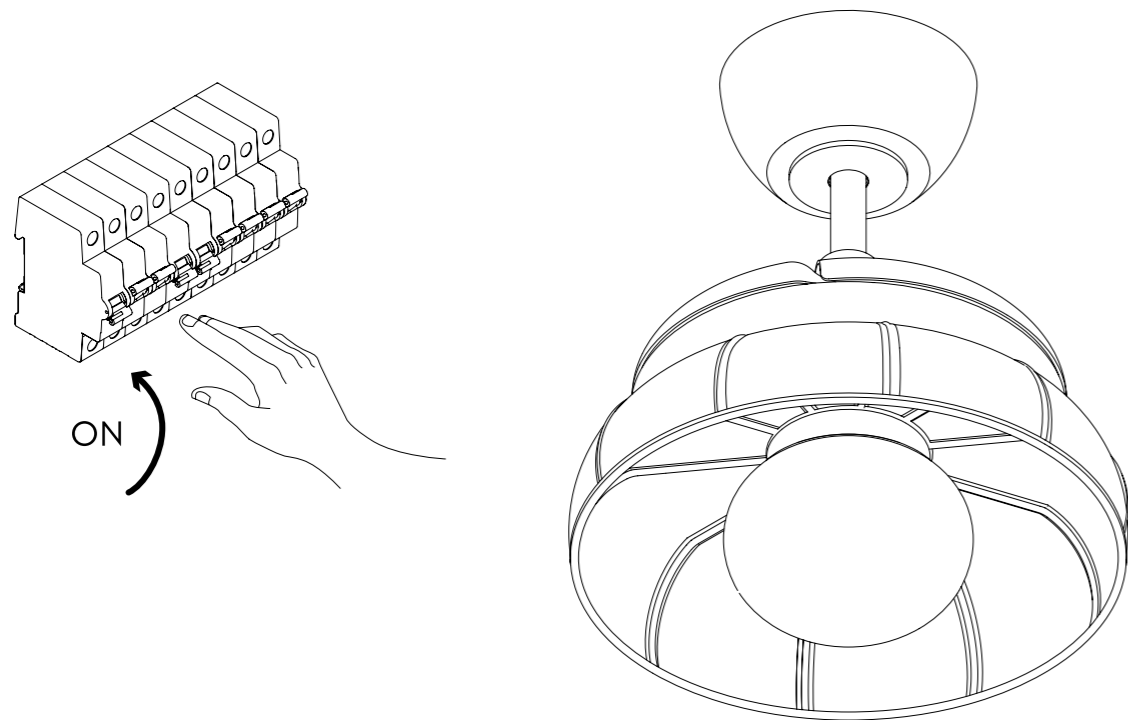

## DECLARACIÓN DE CONFORMIDAD CE

SULION declara bajo su propia responsabilidad que los productos con cuyas referencias estan indicadas en la portada de este manual han sido fabricados en conformidad con los siguientes estándares europeos.

## EC DECLARATION OF CONFORMITY

SULION declares under its own responsibility that the products with references indicated on the cover of this manual have been manufactured in compliance with the following European standards.

## DÉCLARATION DE CONFORMITÉ CE

SULION déclare sous sa propre responsabilité que les produits dont les références sont indiquées sur la couverture de ce manuel ont été fabriqués conformément aux normes européennes suivantes.

## DECLARAÇÃO DE CONFORMIDADE CE

A SULION declara sobre a sua própria responsabilidade que os produtos cujas referências estão indicadas na capa deste manual foram fabricados de acordo com as seguintes normas europeias.

## EC-KONFORMITÄTSERKLÄRUNG

SULION erklärt in eigener Verantwortung, dass die Produkte, deren Referenzen auf dem Umschlag dieses Handbuchs angegeben sind, in Übereinstimmung mit den folgenden europäischen Normen hergestellt wurden.

## DICHIARAZIONE DI CONFORMITÀ CE

SULION dichiara sotto la propria responsabilità che i prodotti le quali referenze vengono indicate sulla copertina di questo manuale sono stati fabbricati in conformità con le seguenti norme europee..

## ΔΗΛΩΣΗ ΣΥΜΜΟΡΦΩΣΗΣ ΕΚ

Η SULION δηλώνει υπό την ευθύνη της ότι τα προϊόντα που αναφέρονται στο εξώφυλλο του εγχειριδίου έχουν κατασκευαστεί σύμφωνα με τα παρακάτω Ευρωπαϊκά πρότυπα.

Directive RED 2014/35/EU	Article 3.1a	EN 60598-1:2015 + A1:2018
		EN 62471:2008
		EN 62493:2010
		EN 60335-1:2012 + A11:2014 + A13:2017 + A1:2019 + A14:2019 + A2:2019
		EN 60335-2-80:2003 + A1:2004 + A2:2009
		EN 62233:2008
		EN 62031:2008 + A1:2013 + A2:2015
		EN IEC 60598-2-1:1989
	Article 3.1b	EN 55014-1:2017 + A11:2020
		EN 55014-2:1997 + A1:2001 + A2:2008
		EN 55015:2019 + A11:2020
		EN 61547:2009
		EN 61000-3-2:2019
		EN 61000-3-3:2013
EN 301 489-1 V2.2.3		
EN 301 489-3 V2.1.1		
Article 3.2	EN 300 220-1 V3.1.1	
	EN 300 220-2 V3.2.1	
Directive RoHS 2015/863/EU	UNE-EN IEC 63000:2018	
ErP Directive 2009/125/EC	Regulation 2019/2020	
	Regulation 206/2012	
	IEC 60879:2019	

  
SULION DIGITAL S.A.

Madrid, 04/02/2026

**C. Schuller**  
CEO

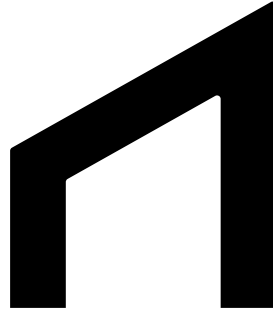

**sulion.es**

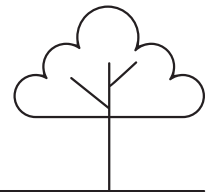

**ES** Elige reparar, no desperdiciar.

Nuestro propósito es generar un impacto positivo en el medio ambiente y en la sociedad. Ofrecemos repuestos fáciles de instalar para evitar devoluciones y reducir residuos. Contacte con nosotros para soluciones responsables y visite [sulion.es](http://sulion.es) para consejos sobre sostenibilidad y eficiencia energética. Juntos creamos los espacios del mañana.

**EN** Choose to repair, not to waste.

Our purpose is to generate a positive impact on the environment and society. We offer easy-to-install spare parts to avoid returns and reduce waste. Contact us for responsible solutions and visit [sulion.es](http://sulion.es) for tips on sustainability and energy efficiency. Together, we create the spaces of tomorrow.

**FR** Choisissez de réparer, pas de gaspiller.

Notre objectif est de générer un impact positif sur l'environnement et la société. Nous proposons des pièces de rechange faciles à installer pour éviter les retours et réduire les déchets. Contactez-nous pour des solutions responsables et visitez [sulion.es](http://sulion.es) pour des conseils sur la durabilité et l'efficacité énergétique. Ensemble, nous créons les espaces de demain.

**PT** Escolha reparar, não desperdiçar.

Nosso propósito é gerar um impacto positivo no meio ambiente e na sociedade. Oferecemos peças de reposição fáceis de instalar para evitar devoluções e reduzir resíduos. Entre em contato conosco para soluções responsáveis e visite [sulion.es](http://sulion.es) para dicas sobre sustentabilidade e eficiência energética. Juntos, criamos os espaços de amanhã.

**DE** Wählen Sie Reparieren statt Wegwerfen.

Unser Ziel ist es, einen positiven Einfluss auf die Umwelt und die Gesellschaft zu haben. Wir bieten einfach zu installierende Ersatzteile an, um Rücksendungen zu vermeiden und Abfall zu reduzieren. Kontaktieren Sie uns für verantwortungsbewusste Lösungen und besuchen Sie [sulion.es](http://sulion.es) für Tipps zu Nachhaltigkeit und Energieeffizienz. Gemeinsam gestalten wir die Räume von morgen.

**IT** Scegli di riparare, non di sprecare.

Il nostro obiettivo è generare un impatto positivo sull'ambiente e sulla società. Offriamo pezzi di ricambio facili da installare per evitare resi e ridurre i rifiuti. Contattaci per soluzioni responsabili e visita [sulion.es](http://sulion.es) per consigli su sostenibilità ed efficienza energetica. Insieme, creiamo gli spazi di domani.

**EL** Επιλέξτε να επισκευάσετε, όχι να σπαταλήσετε.

Σκοπός μας είναι να δημιουργήσουμε θετικό αντίκτυπο στο περιβάλλον και στην κοινωνία. Προσφέρουμε εύκολα στην εγκατάσταση ανταλλακτικά για να αποφύγουμε τις επιστροφές και να μειώσουμε τα απόβλητα. Επικοινωνήστε μαζί μας για υπεύθυνες λύσεις και επισκεφθείτε το [sulion.es](http://sulion.es) για συμβουλές σχετικά με τη βιωσιμότητα και την ενεργειακή απόδοση. Μαζί δημιουργούμε τους χώρους του αύριο.

